

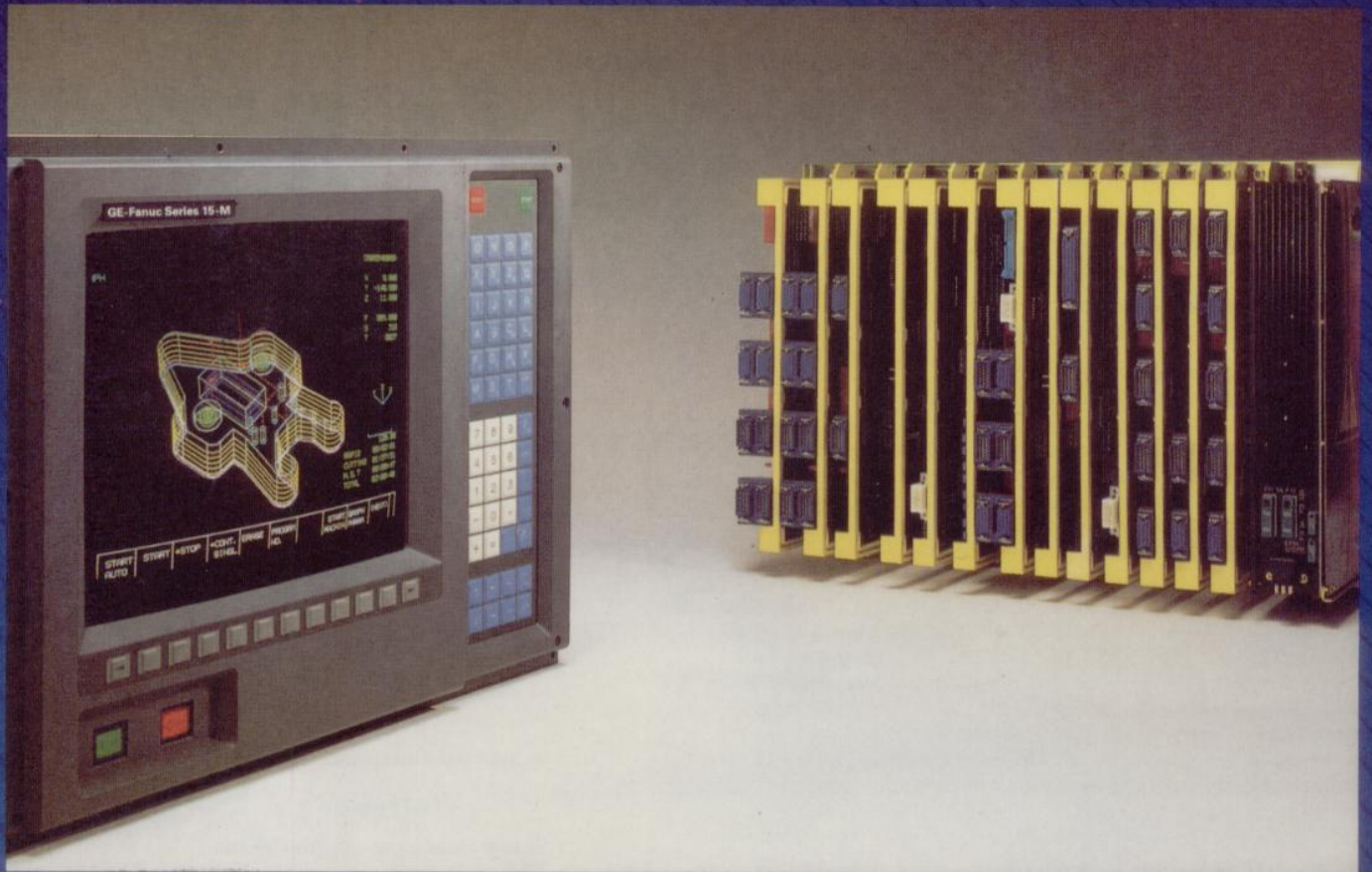

GE Fanuc Automation

Series 15 Computer Numerical Control



The World's Fastest CNC Functions

Ultra-High-Speed Machining for Continuous Short Length Block

Continuous short length block programs to machine complex shapes such as components and molds for planes and cars can operate at high speeds.

Programs for continuous short length block are generally very long. Sometimes they may run to thousands, or even tens of thousands, of meters. Even with a long tape, the host computer sends the command program directly to Series 15 for high-speed DNC operation. Standard, high-speed and super high-speed systems are available. The Series 15 has a standard system using a single 32-bit processor to handle the CNC functions. To meet expanding user needs, systems with high-speed and super high-speed specifications have been made available. The high-speed system uses two 32-bit processors for parallel processing of command program analysis and pulse distribution respectively, while the super high-speed specification features a substantially upgraded performance of the two processors. With these systems, the machining speeds shown in the table below can now be achieved for DNC processing of continuous 1-mm block commands.

		High-speed spec.	Super-high-speed spec.
Simultaneous 3-axis	NC data	15 m/min (4 ms/block)	60 m/min (1 ms/block)
	Binary data	30 m/min (2 ms/block)	120 m/min (0.5 ms/block)

High-speed data transfer is enabled by a remote buffer function provided with a dedicated communication processor and RS422 interface for high-speed reading of the command program from the host computer.

- Data transfer speed using remote buffer protocol A or B: Max. 86.4 Kbps.
- Data transfer speed using remote buffer HDLC protocol: Max. 920 Kbps

High-Resolution, High-Speed Feed

The following feedrate is available for rapid traverse and cutting feed.

- Least input increment
- 0.01 mm: 240 m/min
- 0.0001 mm: 24 m/min
- 0.00001 mm: 2.4 m/min

Acceleration/Deceleration Control Enabling Smooth Machine Operations For Outstanding Cutting Precision

- Linear acceleration/deceleration after interpolation (U.S. Patent No. 4554497)
- Bell-shaped acceleration/deceleration after interpolation
- Look ahead acceleration/deceleration

As Servo control is conducted by feedback in the CNC machine tool, the actual machine position is delayed compared with the command position, causing a servo following error.

This problem has been overcome in the Series 15, where the servo error can be minimized by feed-forward control. The closer the feed-forward coefficient is to 1, the smaller is the servo error, but acceleration/deceleration must be applied to the command pulse being sent to the servo to avoid imparting shock to the machine in corner sections. The Series 15 has been provided with an acceleration/deceleration control function permitting the maximum machine allowance of the feed-forward coefficient.

Acceleration/deceleration after interpolation has the advantage of being automatically applied in corner sections, but has the inadvertent drawback of causing machining error. This can now be avoided by using the function of acceleration/deceleration before interpolation. This look-ahead acceleration/deceleration judges the shape, speed variations and the permissible acceleration about 15 blocks in advance, thereby acceleration/deceleration can be smoothly performed.

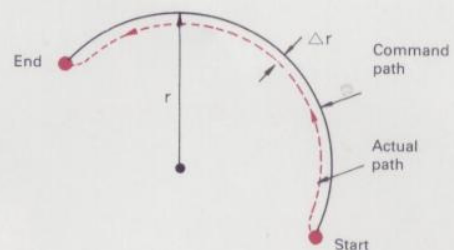

- Δr : max. radial error (mm)
- r : arc radius (mm)
- f : feedrate (mm/sec)
- T_1 : acceleration/deceleration time constant (sec)
- T_2 : servo control time constant (sec)
- a : Feed-forward coefficient ($0 \leq a \leq 1$)

- exponential acceleration/deceleration after interpolation

$$\Delta r \doteq \left(\frac{1}{2} T_1^2 + \frac{1}{2} T_2^2 \right) \frac{f^2}{r}$$

- linear acceleration/deceleration after interpolation

$$\Delta r \doteq \left(\frac{1}{24} T_1^2 + \frac{1}{2} T_2^2 \right) \frac{f^2}{r}$$

- Bell-shaped acceleration/deceleration after interpolation

$$\Delta r \doteq \left(\frac{1}{48} T_1^2 + \frac{1}{2} T_2^2 \right) \frac{f^2}{r}$$

- Look ahead acceleration/deceleration

$$\Delta r \doteq \frac{1}{2} T_2^2 \frac{f^2}{r}$$

When feed-forward control is available, the item $1/2 T_2^2$ in the above 4 formulas becomes as follows.

$$\frac{1}{2} T_2^2 (1 - a^2)$$

Multiple-Axis and Multiple-Path Functions Optimal for Control of Large-Sized Complex Machines

Simultaneous control of up to a maximum of 15 axes is possible, and a maximum of 10 axes such as ATC, and APC can be controlled as auxiliary positioning axes.

A wide range of functions optimal for the control of large-sized machines have been provided. These include "synchronous control" for driving gantry machines, "parallel axis control" for simultaneous movement of 2 or more axes by the same program address, "hybrid control" to effectively increase the servo system gain by combining semi-closed and closed loops, and the "double check system" which performs double feedback of the servo system to prevent erroneous cutting of a valuable workpiece.

Synchronous Control

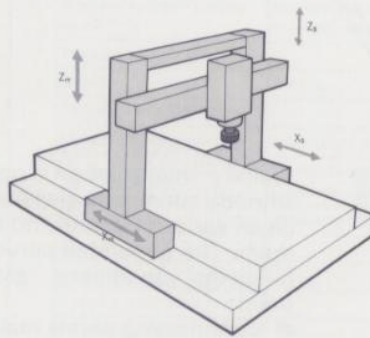

Parallel Axis Control

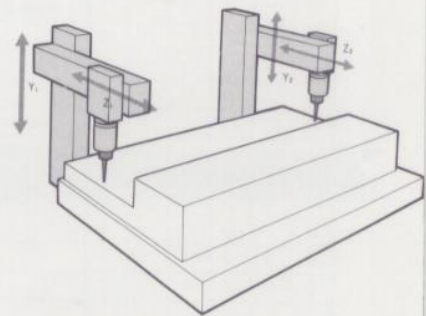

A multiple path function, optimal for use with complex and automatic lathes, has been provided. Simultaneous, independent control can be accomplished just as if there were several CNCs in the one Series 15 unit.

The controlled axis can be changed arbitrarily between two paths, allowing synchronous movement of the controlled axis and spindle in different paths.

Multiple Path Function

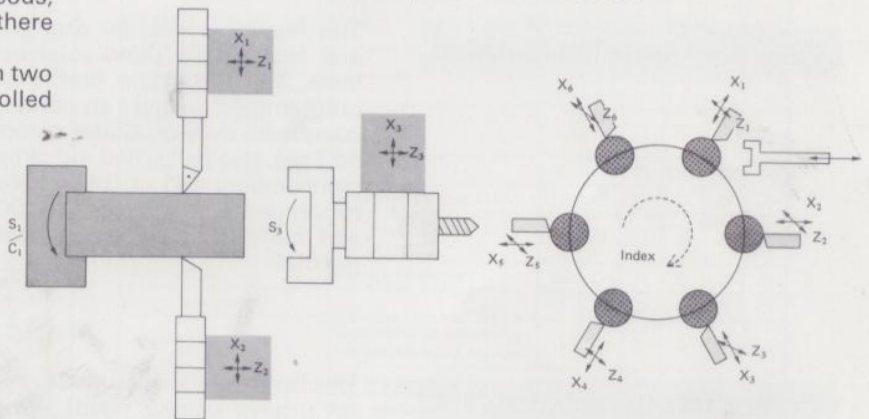

	Specification A	Specification B
Maximum number of paths	4	6
Maximum number of controlled axes	6	15
Maximum number of controlled axes per path	6	8
Maximum number of spindles	2	4

High-speed Communication Functions

The Series 15 has the Manufacturing automation protocol (MAP) based on a factory local area network (LAN), and a protocol DNC1 for a sub-network with the GE Fanuc cell controller. A remote buffer enables high-speed DNC operation with the capacity to transmit data at a maximum speed of 920 KBPS.

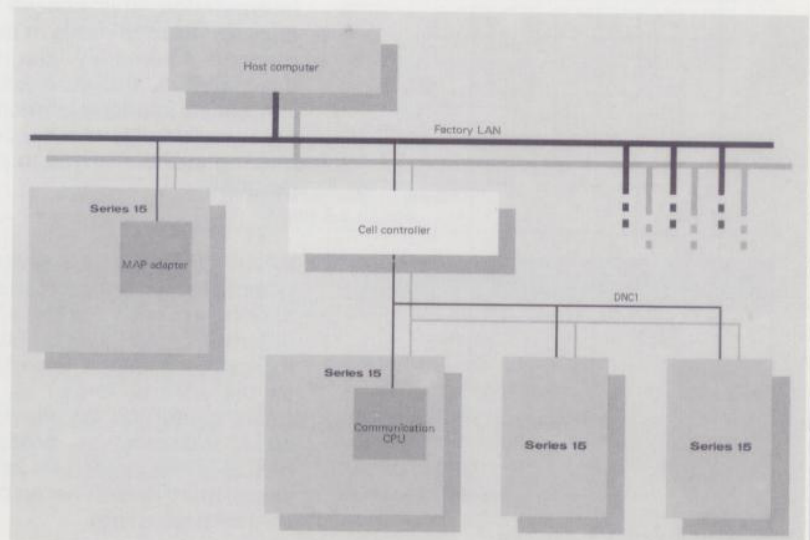

Powerful Interpolation Functions

Involute Interpolation (Patent pending)

Involute interpolation is excellent for processing involuted gears and the scroll part of scroll compressors. When the G41 or G42 command is given, cutter compensation is applied to the involuted curves.

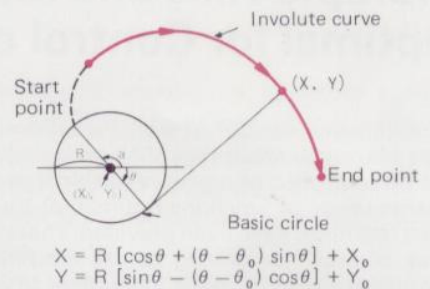

Spline Interpolation

Spline interpolation generates a smooth curve that passes through a given series of points and interpolates them. The generated curve fulfills the following conditions around each point:

- Connecting points match.
- Tangential vectors match.
- The secondary differential vectors (rate of change of tangential vectors) match.

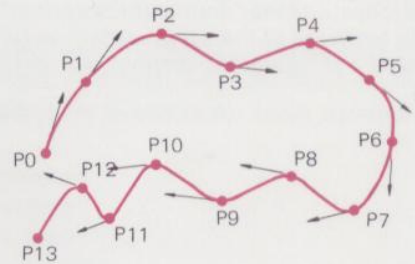

Polar Coordinate Interpolation

This feature is ideal for cam grinding and face milling (X, C axis) using a lathe. The machining profile can be programmed using an orthogonal coordinate system. Cutter compensation can also be carried out simply by commanding G41 or G42. Thereafter, movement of the linear axis (X axis) and rotary axis (C axis) is converted in the CNC.

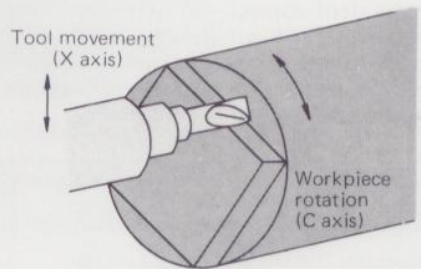

Cylindrical Interpolation

This feature is ideally suited to cylindrical groove cutting needs. Programming can be performed precisely as the cylinder is developed. Cutter compensation is also carried out simply using the G41 or G42 command. The CNC converts this information into rotary axis movement based on the cylinder radius as commanded.

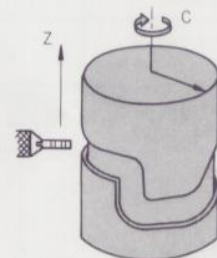

G07 X0; (Hypothetical X-axis)
G91G17G03 X20.Y0.1-10.Z20.F100;

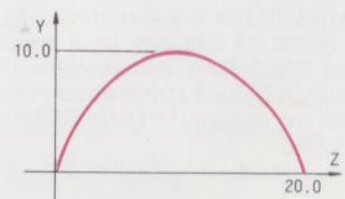

Hypothetical Axis Interpolation

With this function, when one axis in the circular plane is stopped during helical interpolation, this causes the remaining two axes to move in sine configurations. Alternately during circular interpolation, the stop action of one axis can be applied to directly move the other axis, with the feedrate of the moving axis converted to a sine configuration.

Spiral Interpolation

When commands are given for an arc where the arc radius at the start point and the arc radius at the end point are different, spiral interpolation, where the radius changes linearly according to the central angle, is performed. Heart cams can be machined using spiral interpolation. Since arcs with helical interpolation can be moved in a spiral, this movement can be applied to conical processing.

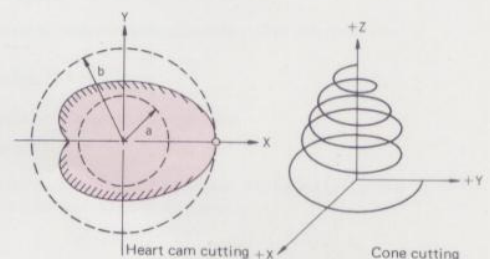

Specifications

Standard

Item	Specification	Series 15					
		MA	MF	TA	TF	TTA	TTF
Controlled axis	2/3 axes	○	○	—	—	—	—
	2 axes	—	—	○	—	—	—
	4 axes	—	—	—	—	○	○
Simultaneous controllable axes	2 axes	○	○	○	○	—	—
	2 axes + 2 axes	—	—	—	—	○	○
Axis name	Optional from X, Y, Z, U, V, W, A, B, C	○	○	—	—	—	—
	Optional from X, Y, Z, B, C in case of G code system A	—	—	○	○	○	○
	Optional from X, Y, Z, U, V, W, B, C in case of G code system B/C	—	—	○	○	○	○
Increment system	0.01, 0.001, 0.0001 mm 0.01, 0.001, 0.0001 deg 0.001, 0.0001, 0.00001 inch	○	○	○	○	○	○
Max. commandable value	±99999999	○	○	○	○	○	○
G code system A/B		—	—	○	○	○	○
Positioning	Linear interpolation type positioning is also possible.	○	○	○	○	○	○
Linear interpolation		○	○	○	○	○	○
Multi-quadrant circular interpolation		○	○	○	○	○	○
Equal lead thread cutting		—	—	○	○	○	○
Inch thread cutting		—	—	○	○	○	○
Continuous thread cutting		—	—	○	○	○	○
Rapid traverse		○	○	○	○	○	○
Tangential speed constant control		○	○	○	○	○	○
Cutting feedrate clamp		○	○	○	○	○	○
Feed per minute		○	○	○	○	○	○
Feed per revolution		—	—	○	○	○	○
Feedrate override	0 - 254%, 1% step	○	○	○	○	○	○
Rapid traverse override	F ₀ , F ₁ , 50%, 100%	○	○	○	○	○	○
Override cancel		○	○	○	○	○	○
Automatic acceleration/deceleration	Rapid traverse Linear or exponential Cutting feed Exponential	○	○	○	○	○	○
Exact stop, exact stop mode, cutting mode		○	○	○	○	○	○
Tapping mode		○	○	—	—	—	—
Dwell	Dwell in seconds and dwell in revolutions (it is possible for 15-MA/MF with thread cutting option)	○	○	○	○	○	○
Reference point return	Manual, automatic (G27, G28, G29)	○	○	○	○	○	○
Machine coordinate system selection	G53	○	○	○	○	○	○
Work coordinate system selection	G54 - G59	○	○	○	○	—	—
Local coordinate system setting	G52	○	○	○	○	—	—
Work coordinate system change	G92	○	○	○	○	○	○
Work coordinate system preset	G92.1	○	○	○	○	—	—
Absolute/incremental programming	Combined use in the same block	○	○	○	○	○	○
Decimal point input/pocket calculator type decimal point input		○	○	○	○	○	○
Diameter/radius programming		○	○	○	○	○	○
S code output	S8-digit command (binary output)	○	○	○	○	○	○
T code output	T8-digit command (binary output)	○	○	○	○	○	○
Miscellaneous function	M8-digit command (binary output)	○	○	○	○	○	○

○ Available — Not available

Standard

Item	Specification	Series 15					
		MA	MF	TA	TF	TTA	TTF
High-speed M, S, T, B interface		○	○	○	○	—	—
Program number/program name	Program number: 4 digits Program name: 16 digits	○	○	○	○	○	○
Program number search		○	○	○	○	○	○
Sequence number	5 digits	○	○	○	○	○	○
Sequence number search		○	○	○	○	○	○
Main program/subprogram	Subprogram: 4 folds nested	○	○	○	○	○	○
Tape code	EIA RS-244, ISO 840 automatic recognition	○	○	○	○	○	○
Tape format	Word address format	○	○	○	○	○	○
Label skip		○	○	○	○	○	○
Control in/out		○	○	○	○	○	○
Optional block skip		○	○	○	○	○	○
Canned cycles for turning		—	—	○	○	○	○
Radius designation on arc		○	○	○	○	○	○
Tool length compensation		○	○	—	—	—	—
Tool offset		—	—	○	○	○	○
Tool offset memory A	Common to all tool offsets	○	○	○	○	○	○
Number of tool offsets	32 pairs (16 pairs on each tool post in case of 15-TTA/TTF)	○	○	○	○	○	○
Incremental offset input		○	○	○	○	○	○
Backlash compensation		○	○	○	○	○	○
Tool length measurement		○	○	—	—	—	—
Direct input of offset value measured		—	—	○	○	○	○
Counter input of offset value		—	—	○	○	○	○
Follow-up	At emergency stop	○	○	○	○	○	○
Servo off and mechanical handle feed		○	○	○	○	○	○
Mirror image	Possible on all axes	○	○	○	○	○	○
Control axis detach		○	○	○	○	○	○
Automatic operation	Tape operation (reader/puncher interface is required)	○	○	○	○	—	—
	Memory operation	○	○	○	○	○	○
	MDI operation	○	○	○	○	○	○
Cycle start/feed fold		○	○	○	○	○	○
Buffer register		○	○	○	○	○	○
Program stop/end		○	○	○	○	○	○
Reset/rewind		○	○	○	○	○	○
Manual continuous feed		○	○	○	○	○	○
Incremental feed	x1, x10, x100, x1000, x10000, x100000	○	○	○	○	○	○
Manual absolute on/off		○	○	○	○	○	○
All axes machine lock		○	○	○	○	○	○
Machine lock on each axis		○	○	○	○	○	○
Auxiliary function lock		○	○	○	○	○	○
Dry run		○	○	○	○	○	○
Single block		○	○	○	○	○	○
Keyboard type manual data input (MDI) and CRT character display	15-MA, 15-TA, 15-TTA: 9" monochrome 15-MF, 15-TF, 15-TTF: 14" color	○	○	○	○	○	○
Display language	Parameter switching between English and Japanese	○	○	○	○	○	○
Clock function		○	○	○	○	○	○
NC format guidance		○	○	○	○	○	○
Data protection key	3 types	○	○	○	○	○	○
Directory display and punch on each group		○	○	○	○	○	○
Part program storage & editing		○	○	○	○	○	○
Extended part program editing		○	○	○	○	○	○
Background editing function		○	○	○	○	○	○

Standard

Item	Specification	Series 15					
		MA	MF	TA	TF	TTA	TTF
Registerable programs (program name display is possible)	100	○	○	○	○	○	○
Part program storage length	15-MA, 15-MF: 80 m 15-TA, 15-TF, 15-TTA, 15-TTF: 40 m	○	○	○	○	○	○
Calculation key		○	○	○	○	○	—
Self-diagnosis functions		○	○	○	○	○	○
Emergency stop		○	○	○	○	○	○
Overtravel		○	○	○	○	○	○
Stored stroke check 1		○	○	○	○	○	○
Interlock	Each axis/all axes/all axes in automatic operation/block start/cutting block start	○	○	○	○	○	○
Status output	CNC ready, servo ready, rewinding, alarm, distribution end, automatic operation, automatic operation start lamp, feed hold, reset, in-position, rapid traversing, tapping, thread cutting, constant surface speed control, inch input and DI status output	○	○	○	○	○	○
PMC function	Program and ladder display by ladder language is possible. Max. 16,000 steps	○	○	○	○	○	○
External power on/off		○	○	○	○	○	○
Connectable servo motor	FANUC AC digital servo motor	○	○	○	○	○	○
Connectable servo unit	PWM transistor drive	○	○	○	○	○	○
Connectable position detector	Pulse coder/optical scale	○	○	○	○	○	○
Connectable spindle motor	FANUC AC spindle motor	○	○	○	○	○	○
Connectable spindle servo unit	PWM transistor servo unit	○	○	○	○	○	○
Power	200VAC +10/-15%, 50/60Hz ±1Hz 220VAC +10/-15%, 60Hz ±1Hz	○	○	○	○	○	○

Option

Item	Specification	Series 15					
		MA	MF	TA	TF	TTA	TTF
Controllable axes expansion (Additional axis)	Max. 15 axes and spindle control	○	—	—	—	—	—
	Max. 8 axes and spindle control	—	—	○	—	—	—
	Max. 6 axes and spindle control	—	○	—	○	○	○
Simultaneous controllable axes expansion		○	○	○	○	○	○
Program axis name expansion	I, J, K and E are added	○	—	—	—	—	—
Increment system D	0.00001mm, 0.000001 inch and 0.00001 deg	○	—	○	—	—	—
High resolution detection interface		○	○	○	○	○	○
G code system C		—	—	○	○	○	○
Single direction positioning		○	○	—	—	—	—
Helical interpolation	Circular interpolation plus max. 2 axes linear interpolation	○	○	○	○	—	—
Helical interpolation B	Circular interpolation plus max. 4 axes linear interpolation	○	○	○	○	—	—
Hypothetical axis interpolation		○	○	○	○	○	○
Polar coordinate interpolation		○	○	○	○	○	○
Cylindrical interpolation		○	○	○	○	○	○
Exponential interpolation		○	○	—	—	—	—
Involute interpolation		○	○	○	○	○	○
Spline interpolation		○	○	○	○	—	—
Thread cutting, per revolution feed	Inch thread cutting, continuous thread cutting, per revolution feed	○	○	*1	*1	*1	*1
Variable lead thread cutting		—	—	○	○	○	○
Circular thread cutting		—	—	○	○	○	○
Circular thread cutting B		○	○	—	—	—	—
Thread cutting cycle retract		—	—	○	○	○	○
Inverse time feed		○	○	—	—	—	—
F1-digit feed		○	○	—	—	—	—
2nd feedrate override		○	○	○	○	○	○
Linear acceleration/deceleration after cutting feed		○	○	—	—	—	—
Bell-shaped acceleration/deceleration after cutting feed		○	○	—	—	—	—
Linear acceleration/deceleration before cutting feed		○	○	○	○	○	○
Acceleration/deceleration before pre-read interpolation		○	○	—	—	—	—
Automatic corner override		○	○	○	○	○	○
2nd reference point return		○	○	○	○	○	○
3rd to 4th reference point return		○	○	○	○	○	○
Floating reference point return		○	○	○	○	○	○
Programmable data input	Tool offset amount, work zero point offset amount can be changed by programming. (G10)	○	○	○	○	○	○
Additional work coordinate system	48 pairs	○	—	—	—	—	—
Polar coordinate command		○	○	—	—	—	—
Inch/metric conversion		○	○	○	○	○	○
Spindle speed binary/analog output	Spindle speed clamp command is possible. Max. 60,000 rpm	○	○	○	○	○	○
Constant surface speed control		○	○	○	○	○	○
Actual spindle speed output		○	○	○	○	○	○
Spindle positioning		○	○	○	○	—	—
Spindle speed fluctuation detection		○	○	○	○	—	—
Tool life management		○	○	○	○	○	○
Tool life management 512 pairs		○	○	—	—	—	—
Turret axis control		—	—	○	○	—	—
2nd auxiliary function	8 digits, binary output (select address from A, B, C, U, V and W so that it does not duplicate with control axes address)	○	○	○	○	○	○

*1: Standard

Option

Item	Specification	Series 15					
		MA	MF	TA	TF	TTA	TTF
1 block plural M command		○	○	○	○	—	—
48-character program name		○	○	○	○	○	○
Optional block skip addition		○	○	○	○	○	○
Canned cycles		○	○	—	—	—	—
Multiple repetitive cycles for turning		—	—	○	○	○	○
Canned cycles for drilling		—	—	○	○	○	○
Rigid tap		○	○	○	○	—	—
Chamfering/corner R		—	—	○	○	○	○
Optional angle chamfering/corner R		○	○	—	—	—	—
Programmable mirror image		○	○	○	○	—	—
Mirror image for double turret		—	—	○	○	—	—
Index table indexing		○	○	—	—	—	—
Figure copying		○	—	—	—	—	—
Direct drawing dimensions programming		—	—	○	○	○	○
Tool offset		○	○	—	—	—	—
Cutter compensation B		○	○	—	—	—	—
Cutter compensation C		○	○	—	—	—	—
Tool nose radius compensation		—	—	○	○	○	○
3-dimensional tool compensation		○	○	—	—	—	—
Tool offset selection by T code		○	○	—	—	—	—
Tool offset memory B	Geometry/wear memory	○	○	○	○ ²	○	○
Tool offset memory C	Distinction between geometry and wear, or between cutter and tool length compensation	○	○	—	—	—	—
Additional tool offset pairs	Tool 99/200/499/999 pairs	○	○	—	—	—	—
Tool offsets 64 pairs	32 pairs in each tool post in case of 15-TTA, 15-TTF	—	—	○	○	○	○
Tool offsets 160 pairs		—	—	○	○	—	—
Tool offset value digit expansion	Number of tool offset pairs becomes half. 8-digit: Metric input 9-digit: Inch input	○	—	○	—	—	—
Tool length compensation in tool axis direction		○	○	—	—	—	—
3-dimensional handle feed		○	○	—	—	—	—
Stored pitch error compensation		○	○	○	○	○	○
Inclination compensation		○	○	○	○	—	—
Straightness compensation		○	○	○	○	—	—
Programmable parameter input		○	○	○	○	○	○
Axis switching		○	○	—	—	—	—
Scaling		○	○	—	—	—	—
Coordinate system rotation		○	○	—	—	—	—
3-dimensional coordinate system conversion		○	○	—	—	—	—
Skip function		○	○	○	○	○	○
Multi-step skip function		○	○	—	—	—	—
High-speed skip signal input		○	○	○	○	○	○
Automatic tool length measurement		○	○	—	—	—	—
Automatic tool offset		—	—	○	○	○	○
High-speed measuring position reach signal input		○	○	○	○	○	○
Tool length/work zero point measurement B		○	○	—	—	—	—
Work origin compensation measured value direct input		—	○	—	—	—	—
Direct input of offset value measured B		—	—	○	○	○	○
Custom macro	Common variable: 100 (50 on each tool post in case of 15-TTA, 15-TTF) DI/DO = 128/128	○	○	○	○	○	○
Custom macro common	Total 200/300/600 (100/150 on each tool post in case of 15-TTA, 15-TTF)	○	○	○	○	○	○
Interruption type custom macro		○	○	○	○	○	○

² Standard

Option

Item	Specification	Series 15					
		MA	MF	TA	TF	TTA	TTF
Macro compiler & executor		○	—	○	—	—	—
Key and program encryption		○	○ ³	○	○	○	○
High-speed machining function		○	○	○	○	○	○
Multi-buffer	15 blocks	○	○	○	○	—	—
Automatic corner deceleration		○	○	—	—	—	—
Feedrate clamp by circular radius		○	○	—	—	—	—
Feed stop		○	○	○	○	○	○
Arbitrary command multiply		○	○	—	—	—	—
Parallel axis control		○	—	—	—	—	—
Twin table control		○	○	—	—	—	—
Normal direction control		○	○	—	—	—	—
Chopping function		○	○	—	—	—	—
Synchronous/independent switching		—	—	○	○	—	—
Polygon turning		—	—	○	○	—	—
Axis control by PMC		○	○	○	○	○	○
Synchronous control	Synchronous error compensation is possible.	○	—	○	—	—	—
Simple synchronous control		○	○	—	—	—	—
Hybrid control		○	—	○	—	—	—
Sequence number comparison and stop		○	○	○	○	—	—
Program restart		○	○	○	○	—	—
Block restart		○	○	○	○	—	—
Tool retract & recover		○	○	○	○	—	—
Handle interruption		○	○	○	○	—	—
Automatic/manual simultaneous		○	○	○	○	—	—
Retrace		○	○	—	—	—	—
Manual handle feed (1st)		○	○	○	○	○	○
Manual handle feed (2nd, 3rd)		○	○	○	○	○	○
Manual arbitrary angle feed	Unit of angle: 1/16 deg	○	○	—	—	—	—
Manual numerical command		○	○	○	○	○	○
Manual feed per revolution		—	—	○	○	—	—
Display language selection	Japanese, English, German, French, Italian, Spanish, Swedish	○	○	○	○	○	○
14" color CRT		○	○ ⁴	○	○ ⁴	○	○ ⁴
Run hour display		—	—	—	—	○	○
Run hour and parts count display		○	○	○	○	—	—
Load meter display		○	○	○	—	—	—
Menu switch		○	○	○	○	—	—
Software operator's panel		○	○	○	○	—	—
Graphic display	(14" color CRT is required)	○	—	○	—	—	—
NC formal guidance with figure		○	○	○	—	—	—
Simple conversational automatic function	(only 9" CRT)	○	—	○	—	—	—
Machining time stamp function		○	○	○	○	○	○
Registered programs	200/400/1000	○	○	○	○	○	○
Part program storage length	160/320/640/1280/2560/5120m 80/160/320/640/1280/2560/5120m	○	○	—	—	—	—
Playback		○	○	○	○	—	—
Override playback		○	○	—	—	—	—
External I/O device control		○	○	○	○	○	○
Trouble diagnosis guidance		○	○	○	○	○	○
Tape reader without reels		○	○	○	○	○	○
Tape reader with reels		○	○	○	○	○	○
Reader/puncher interface A	RS-232-C x 2 Directory display of floppy cassette is possible. Rewind of portable tape reader is possible	○	○	○	○	○	○
Reader/puncher interface B	RS-232-C x 1 Directory display of floppy cassette is possible. RS-422 x 1 Rewind of portable tape reader is possible.	○	○	○	○	○	○

³, ⁴ Standard

Option

Item	Specification	Series 15					
		MA	MF	TA	TF	TTA	TTF
Remote buffer interface		○	○	○	○	—	—
Bubble cassette and adaptor		○	○	○	○	○	○
Floppy cassette and adaptor		○	○	○	○	○	○
FANUC PPR		○	○	○	○	○	○
Portable tape reader		○	○	○	○	○	○
FANUC PROGRAM FILE Mate		○	○	○	○	○	○
FANUC FA Card and adaptor		○	○	○	○	○	○
Stored stroke check 2		○	○	—	—	—	—
Stored stroke check 2, 3		—	—	○	○	○	○
Stroke check before move		○	○	○	○	○	○
Chuck & tail stock barrier		—	—	○	○	—	—
Door interlock		○	○	○	○	○	○
External deceleration		○	○	○	○	○	○
Axis moving signal	Axis moving signal output, axis moving direction signal output.	○	○	○	○	○	○
External data input/output	Input/output of tool offset amount, work zero offset amount, machine zero offset amount, alarm message, operator message, program number search, sequence number search, macro variable are available.	○	○	○	○	○	○
External work number search		○	○	○	○	○	○
PMC nonvolatile memory 64KB		○	○	○	○	—	—
Key input from PMC		○	○	○	○	—	—
NC window		○	○	○	○	○	○
NC window B		○	○	○	○	—	—

Option

Item	Specification	Series 15					
		MA	MF	TA	TF	TTA	TTF
Absolute position detector		○	○	○	○	○	○
Balanced cutting		—	—	—	—	○	○
Tool post interference check		—	—	—	—	○	○
PMC PASCAL function	Max. 424KB	○	○	○	○	○	○
Multi-tap transformer	200/220/230/240/380/415/440/480/550 V AC	○	○	○	○	○	○
Conversational automatic a programming function III		—	○	—	—	—	—
Override playback		—	○	—	—	—	—
Contour figure repetition function		—	○	—	—	—	—
NC format output		—	○	—	—	—	—
FANUC standard conversational macro program C, D		—	○	—	—	—	—
Conversational pascal programming		—	○	—	—	—	—
FANUC standard conversational pascal program C, D		—	○	—	—	—	—
Arbitrary path editing function		—	○	—	—	—	—
Conversational ROM file		—	○	—	—	—	—
Sub cycle function		—	—	—	○	—	○
Automatic process determination function		—	—	—	○	—	○
Animated drawing function		—	—	—	○	—	○
C-axis FAPT function		—	—	—	○	—	○
Automatic collision avoidance function		—	—	—	—	—	○
Balance cut FAPT function		—	—	—	—	—	○
Sub memory addition		—	—	—	○	—	○